

# D802-LED

## 12" Low-Profile Area Light

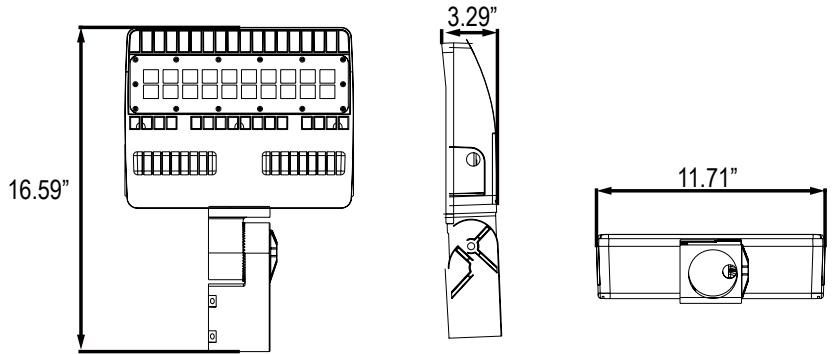

### Job Information

Type:	
Catalog #:	
Project:	
Comments:	
Prepared by:	

### Description

The D802-LED utilizes a soft-cornered aerodynamic design to provide excellent light distribution and an aesthetically appealing appearance. Ideal for storage areas, rail yards, loading docks, and building perimeters. One piece die cast aluminum door has two captive stainless steel fasteners and can be removed from the die cast aluminum housing for easy maintenance. Attractive dark bronze, polyester powder coated finish for excellent impact, corrosion and UV resistance.

### Features

- High pressure die casting housing ,anti-static powder painting.
- High thermal conductive material and high efficiency cooling system.
- ETL Listed; IP66 rated
- Delivers up to 120 lumens per watt at 5000K
- Precise light cutoff, less than 5 lumens of light above 90°
- Weight: 13 lbs (75W); 13.5 lbs (100W)
- 10-Year Limited Warranty

### Ordering Information

Example: (D802-LED-75-40-U-T3-SF-BZ-T)

D802-LED														
Series	Wattage/Lumen		Color Temp.		Voltage	Optics		Mounting		Finish		Option		
12" Area Light	75	75W/9500 <sup>1,2</sup>	40	4000K <sup>2</sup>	U	120-277V	T3	Type 3 <sup>2</sup>	PM	Pole Mount	BZ	Bronze	T	Photocell
	100	100W/12950 <sup>1,2</sup>	50	5000K <sup>2</sup>			T5		Type 5					
									SF	Slip Fitter				

<sup>1</sup> Delivered Lumens (4000K) - For 5000K multiply by 1.03  
<sup>2</sup> DLC Listed (See Page 3 for more information on models currently listed)

### Photometric Data

100W 4000K

Polar Candela Distribution

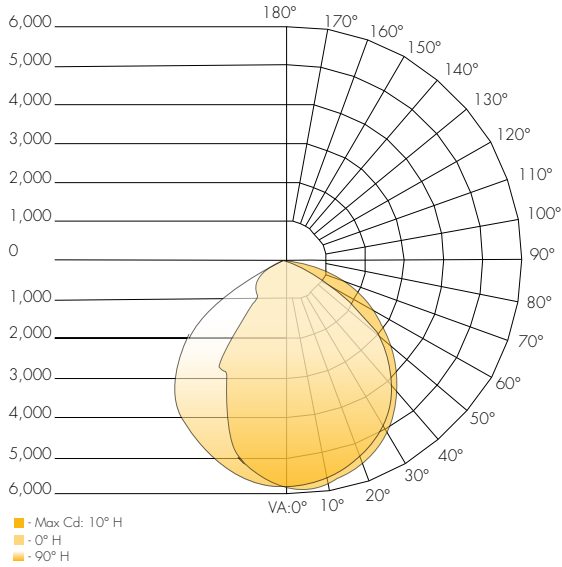

Isolux Plot

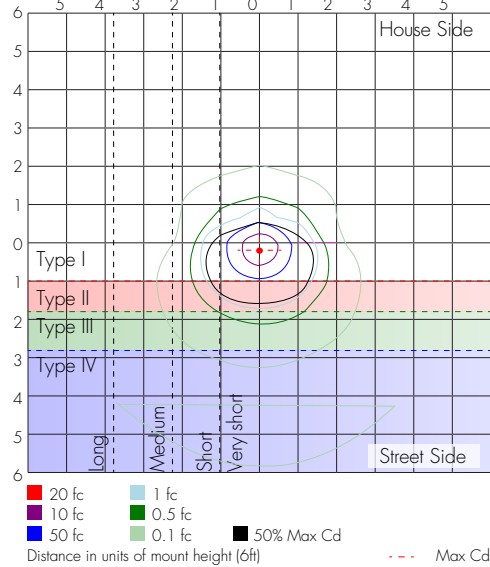

Zonal Lumen Summary

Zone	Lumens	%Lamp	%Luminaire
0-30	4,303.9	33.2%	33.2%
0-40	6,756.8	52.1%	52.1%
0-60	10,921.3	84.2%	84.2%
60-90	2,053.3	15.8%	15.8%
70-100	790.4	6.1%	6.1%
90-120	0.6	0%	0%
0-90	12,974.6	100%	100%
90-180	1.3	0%	0%
0-180	12,975.91	100%	100%

LCS Graph

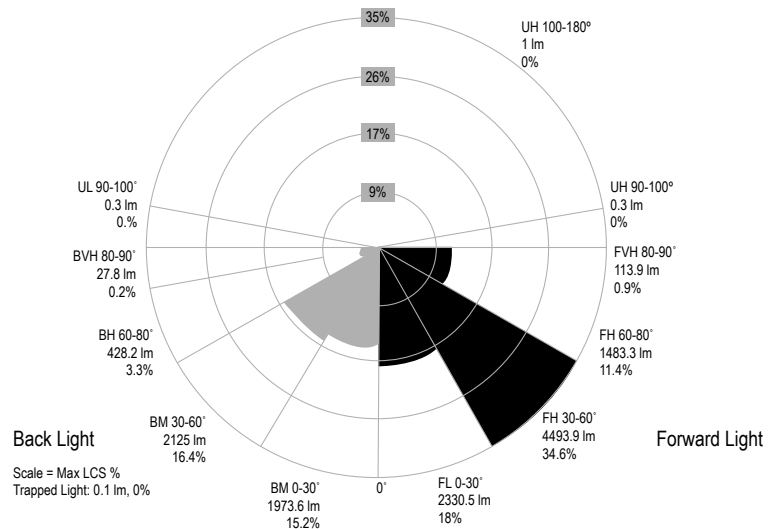





### Performance Data

CRI:	75+
CCT:	4000K, 5000K
Dimming:	Available with 0-10V inputs dimming down to 10%
Operating Temperature:	-40°C to 40°C Ambient
IP Rating:	IP66
Power Factor:	> 0.95
Total Harmonic Distortion (THD):	< 10%

### DLC Listed

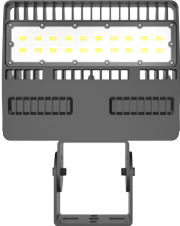
	75W		100W	
	T3	T5	T3	T5
4000K	X		X	
5000K	X		X	

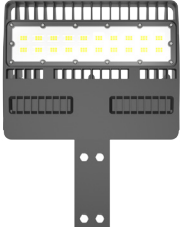
### Mounting Options

	Front Side	Side View
Yoke Mount		
Pole Mount		
Slip Fitter	