

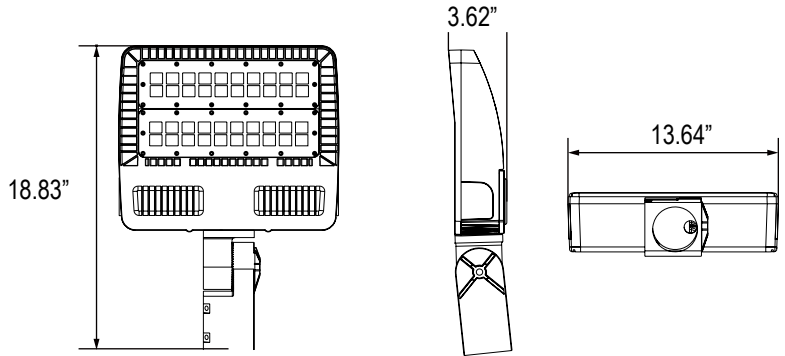

DECO® | LIGHTING

D804-LED

14" Low-Profile Area Light



Job Information

Type:	
Catalog #:	
Project:	
Comments:	
Prepared by:	

Description

The D804-LED utilizes a soft-cornered aerodynamic design to provide excellent light distribution and an aesthetically appealing appearance. Ideal for storage areas, rail yards, loading docks, and building perimeters. One piece die cast aluminum door has two captive stainless steel fasteners and can be removed from the die cast aluminum housing for easy maintenance. Attractive dark bronze, polyester powder coated finish for excellent impact, corrosion and UV resistance.

Features

- High pressure die casting housing ,anti-static powder painting.
- High thermal conductive material and high efficiency cooling system.
- ETL Listed; IP66 rated
- Delivers up to 120 lumens per watt at 5000K
- Precise light cutoff, less than 5 lumens of light above 90°
- Weight: 17 lbs
- 10-Year Limited Warranty

Ordering Information

Example: (D804-LED-150-50-U-T3-PM-BZ-T)



Series	Wattage/Lumen	Color Temp.	Voltage	Optics	Mounting	Finish	Option
14" Area Light	150 150W/18150 ^{1,2}	40 4000K ² 50 5000K ²	U 120-277V	T3 Type 3 ² T5 Type 5	PM Pole Mount YM Yoke Mount SF Slip Fitter	BZ Bronze	T Photocell

¹ Delivered Lumens (4000K) - For 5000K multiply by 1.03

² DLC Listed (See Page 3 for more information on models currently listed)



Deco Lighting practices a program of continuous product development, and as a result product specifications change frequently. We reserve the right to change product specifications without notice. Contact Deco for the latest product information.

©2018 Deco Lighting, www.getdeco.com T: (800) 613-DECO F: (310) 366-6855
Rev Date: 02/01/2018 #2

Digitize your light.®

Photometric Data

150W 4000K

Polar Candela Distribution

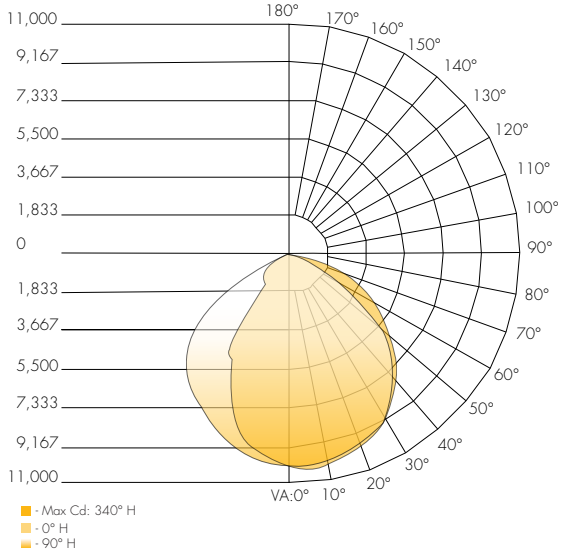

Isolux Plot

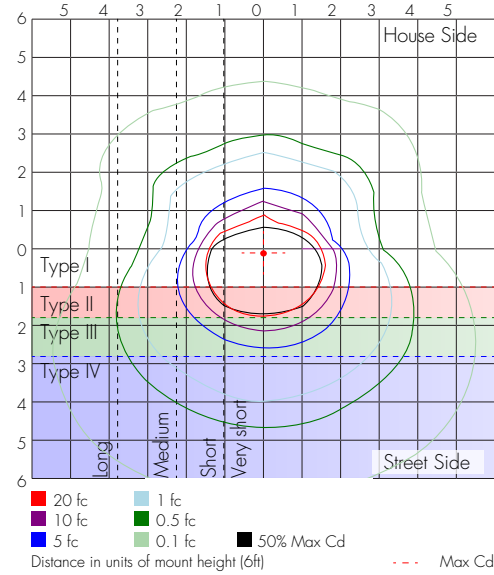

Zonal Lumen Summary

Zone	Lumens	%Lamp	%Luminaire
0-30	6,084.9	33.5%	33.5%
0-40	9,584.1	52.8%	52.8%
0-60	15,248.0	84.0%	84.0%
60-90	2,895.0	16.0%	16.0%
70-100	1,127.6	6.2%	6.2%
90-120	0.7	0%	0%
0-90	18,143.0	100%	100%
90-180	1.7	0%	0%
0-180	18,144.8	100%	100%

LCS Graph

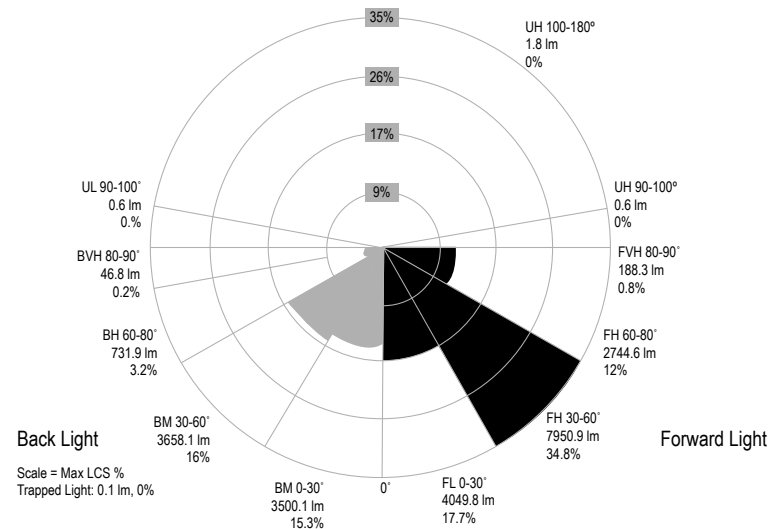





Performance Data

CRI:	75+
CCT:	4000K, 5000K
Dimming:	Available with 0-10V inputs dimming down to 10%
Operating Temperature:	-40°C to 40°C Ambient
IP Rating:	IP66
Power Factor:	> 0.95
Total Harmonic Distortion (THD):	< 10%

DLC Listed

	150W	
	T3	T5
4000K	X	
5000K	X	

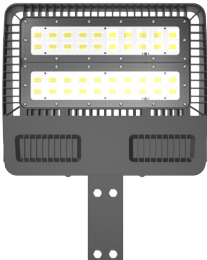
Mounting Options

	Front Side	Side View
Yoke Mount		
Pole Mount		
Slip Fitter	